

2025

SHEERVUEW

HORIZONTAL SHEER SHADE



PRODUCT GUIDE

TABLE OF CONTENTS



Sheerview Shade Features	1
Available Colors	2-6
Child Safety Information	7-9
Brackets, Headrail, and Bottomrail Information	10
Product Diagrams	11
Motorized Wand and Remote Pricing	14
Pricing Grids - MSRP	15-19
Measuring	20
Miscellaneous Information	21
Product Operating	22
Programming Information	23

SHEERVIEW SHADE FEATURES



- A shade of unique beauty and performance for the finishing touch to your window and room.
- Horizontal fabric vanes float between two layers of soft, knitted sheers to enlighten your view.
- New vane fabrics feature a softer look for your windows.
- Available in widths up to 116" and drops to lengths of 144" to lend elegance to the widest of windows.
- Vanes glide from open to closed to out-of-sight with graceful, efficient hardware.
- The Sheerview control system provides distinct variations of vane positions for any combination of privacy, view and light control.
- An adjustable weight system hidden in the bottom rail allows for on-the-spot adjustment to lend a balanced appearance in the window.
- Color coordinated, fabric wrapped headrail and a fabric-wrapped bottom rail offer a sophisticated look.
- All Inside Mounted (IB) Shades will have a light gap on the left and right side. The side with the controls will have a slightly larger light gap.
- Easy to install hardware and brackets allow for effortless setup and easy removal for cleaning.
- Sheerview Shades can be ultrasonically or traditionally cleaned to stay bright and beautiful.
- UV protected for up to 5 years.

AVAILABLE COLORS

S50 = 50mm = 2" Vanes Color # = 000 BN = Printed PN = Non Woven D = Room Darkening

PRICE GROUP 1

2" LIGHT FILTERING



BRIGHT WHITE
S50PN100



WINTER WHITE
S50PN113



BEIGE
S50PN322



ALABASTER
S50PN112



BLOSSOM
S50PN206



GRANITE
S50PN823



SESAME
S50PN302

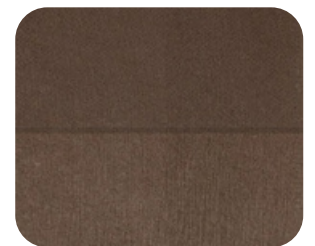

JAVA
S50PN378

S65 = 65mm = 2.5" Vanes Color # = 000 BN = Printed PN = Non Woven D = Room Darkening

PRICE GROUP 2

2.5" LIGHT FILTERING



WATERFALL
S65BN627



BEIGE
S65BN322



HEATHER
S65BN311



BLUSH
S65BN312



GRANITE
S65BN823



BLOSSOM
S65BN206



PARMESAN
S65BN125



OAT
S65BN414



FOGGY
S65BN517



ECRÚ
S65BN207



SMOKE
S65BN503



WHALE
S65BN822

AVAILABLE COLORS

S70 = 70mm = 3" Vanes

Color # = 000 BN = Printed PN = Non Woven D = Room Darkening

PRICE GROUP 3

3" LIGHT FILTERING



BRIGHT WHITE
S70PN100



WINTER WHITE
S70PN113

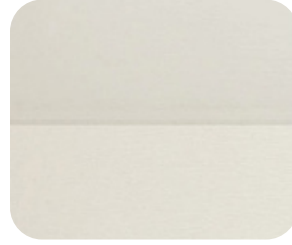

BEIGE
S70PN322

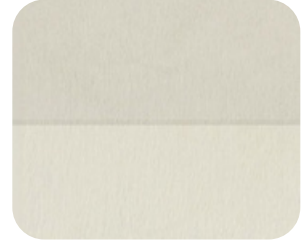

ALABASTER
S70PN112



BLOSSOM
S70PN206

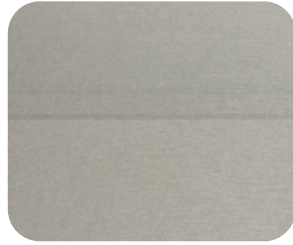

GRANITE
S70PN823

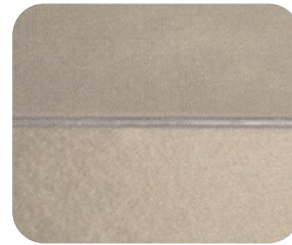

SESAME
S70PN302



JAVA
S70PN378



ROMANCE
S70PN323



LUNA
S70PN126

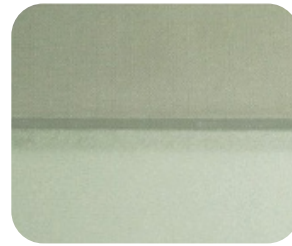

CELADON
S70PN517



COASTAL PLAIN
S70PN503

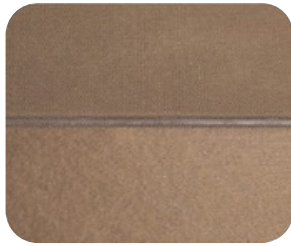

PLANK
S70PN371



RHINESTONE
S70PN824

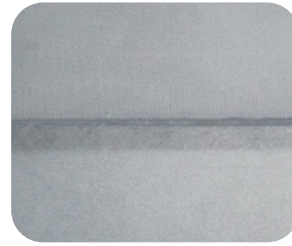

DUSTY BLUE
S70PN821

AVAILABLE COLORS

S50 = 50mm = 2" Vanes Color # = 000 BN = Printed PN = Non Woven D = Room Darkening

PRICE GROUP 4

2" ROOM DARKENING



BRIGHT WHITE
S50PN100D



BEIGE
S50PN322D

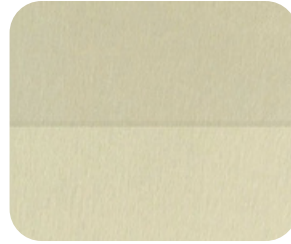

LINEN
S50PN125D

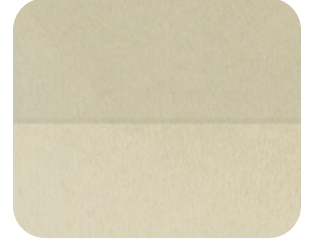

CORNSILK
S50PN414D



BISCUIT
S50PN145D



GRANITE
S50PN823D



WINTER WHITE
S50PN113D

S65 = 65mm = 2.5" Vanes Color # = 000 BN = Printed PN = Non Woven D = Room Darkening

PRICE GROUP 5

2.5" ROOM DARKENING



HEATHER
S65BN311D



BLUSH
S65BN312D



BLOSSOM
S65BN206D



BEIGE
S65BN322D



GRANITE
S65BN823D



WATERFALL
S65BN627D

AVAILABLE COLORS

S70 = 70mm = 3" Vanes

Color # = 000 BN = Printed PN = Non Woven D = Room Darkening

PRICE GROUP 6

3" ROOM DARKENING



BRIGHT WHITE
S70PN100D



BEIGE
S70PN322D



LINEN
S70PN125D

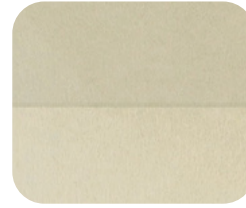

CORNSILK
S70PN414D



BISCUIT
S70PN145D



GRANITE
S70PN823D



JAVA
S70PN378D



GREEK VILLA
S70PN114D



EGGSHELL
S70PN111D



NATURAL TAN
S70PN321D



BARCELONA BEIGE
S70PN312D

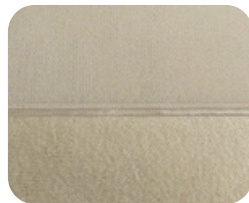

KHAKI
S70PN303D



BRICK
S70PN334D



LAZY GRAY
S70PN822D



MIDNIGHT
S70PN016D



ROYAL BLUE
S70PN029D

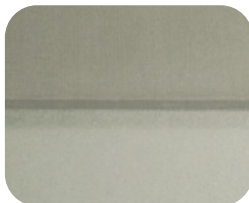

COASTAL PLAIN
S70PN503D

FLAT SQUARE HEADRAIL COLORS



PECAN
LD-L334



WHITE
LD-S113



SESAME
LD-S302



BEIGE
LD-S322



COCOA
LD-S378



CORNSILK
LD-S414



DOLPHIN GRAY
LD-S503



RATTAN
LD-S823



NIGHT SKY
LD-V110



BLUEBERRY
LD-V113



SAGE
LD-ZY090



CELEDON
LD-S517

CHILD SAFETY INFORMATION

THE MANUFACTURER IS COMMITTED TO CHILD SAFETY REGARDING WINDOW COVERINGS

The Manufacturer has committed to join the Window Covering Manufacturers Association's new safety standards in the efforts to prevent accidents involving children and pets with accessible cords and by offering other product options that are child-safe custom window coverings.

"BEST FOR KIDS" CERTIFIED PROGRAM

Window Covering Manufacturers Association (WCMA) announced the industry's first third-party certification program designed to help consumers and retailers identify window covering products that are best suited for use in homes with young children.

To be part of the new Best for Kids program, products are submitted to a WCMA-recognized third party testing laboratory where the products are required to meet stringent criteria. Once the products meet these criteria, they are Certified Best For Kids. The Manufacturer has a number of products with this distinction.



CHILD SAFETY IS SERIOUS BUSINESS

That's why the Manufacturer is removing all cords from products, in compliance with the Consumer Product Safety Commission's new guidelines for child-safe window treatments. A variety of control options, including the Safety Wand, traditional cordless control, and motorization, are available, providing the same convenience while making safety a top priority.

For more information on the CPSC's new guidelines and the Manufacturer's compliance with them, please visit: [federalregister.gov/documents/2022/11/28/2022-25041/safety-standard-for-operating-cords-on-custom-window-coverings](https://www.federalregister.gov/documents/2022/11/28/2022-25041/safety-standard-for-operating-cords-on-custom-window-coverings).

REESE'S LAW

These products are designed and manufactured in compliance with Reese's Law (P.L. 117-171), including the safety standard for button cell and coin batteries (16 CFR Part 1263), which incorporates by reference UL 4200A-2023.

<h2>⚠️ WARNING</h2>	
<ul style="list-style-type: none">• INGESTION HAZARD: This product contains a button cell or coin battery• DEATH or serious injury can occur if ingested.• A swallowed button cell or coin battery can cause Internal Chemical Burns in as little as 2 hours.• KEEP new and used batteries OUT OF REACH of CHILDREN• Seek immediate medical attention if a battery is suspected to be swallowed or inserted inside any part of the body.	The icons include a yellow triangle with a black exclamation mark above a yellow battery, a diagonal slash, and a blue circle with a white silhouette of an adult and a child.

OUR SOLUTION

In compliance with the CPSC's new guidelines for child safety, our standard CCL Safety Tension Device offers superior safety which can be mounted to the frame of the window.



Outside Mount

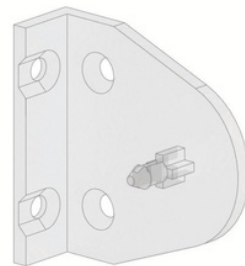

These devices meet the requirements of the ANSI/WCMA A100.1-2022 standard, which is the industry standard for window covering safety.

OUR SOLUTION

The new, optional, Safe Wand control system, introduced in compliance with the CPSC's new guidelines for child safety, offers superior safety without compromising on convenience.

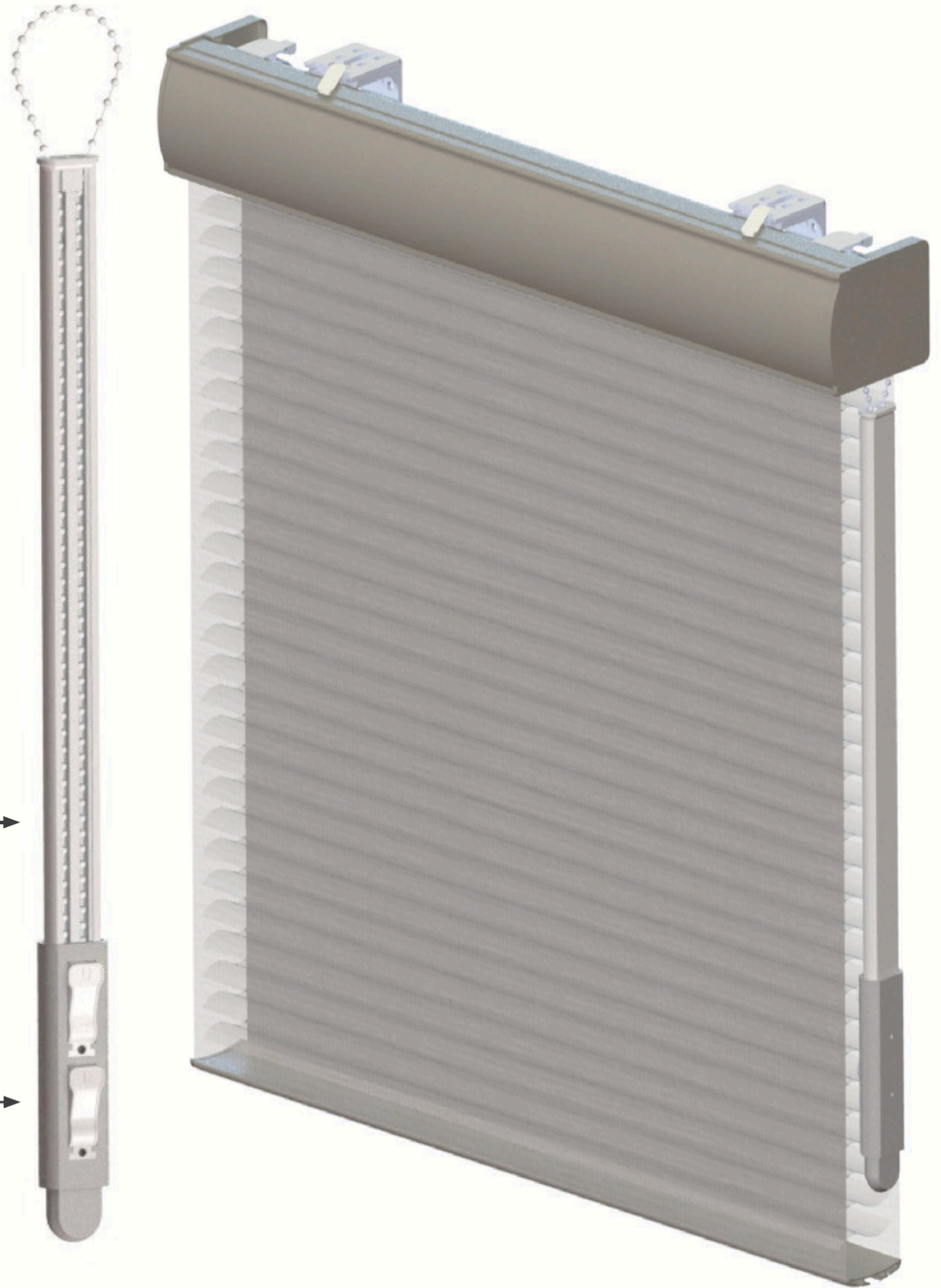

Optional →

Hold ↑ button and slide
along wand to raise shade

or

Hold ↓ button and slide
along wand to lower shade →

These devices meet the requirements of the ANSI/WCMA A100.1-2022 standard, which is the industry standard for window covering safety.

BRACKETS, HEADRAIL AND BOTTOM RAIL INFORMATION

CURVED HEADRAIL BRACKETS

Easy to install One Clip Brackets, come with shims to even the shade if the window jamb is uneven.



CURVED HEADRAIL
(standard option)

Matching fabric wrapped comes standard

STOPPERS

Prevents the bottom-rail from looping up into the headrail when raised up, or with motorization.



FLAT HEADRAIL BRACKETS

Easy to install One Clip Brackets, come with shims to even the shade if the window jamb is uneven.



FLAT HEADRAIL
(upgrade option)

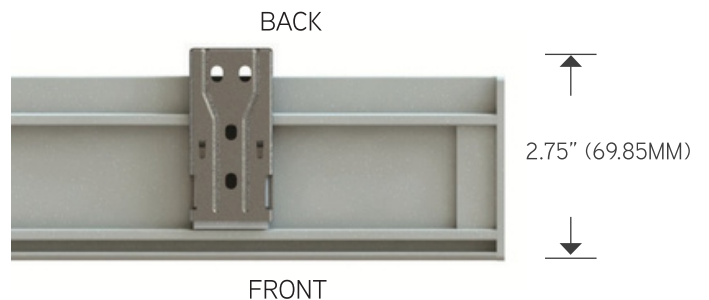
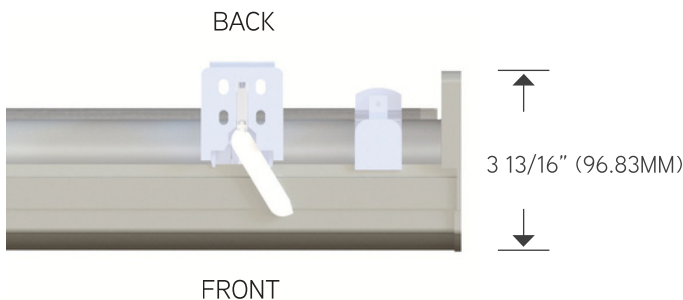
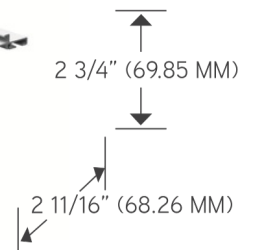
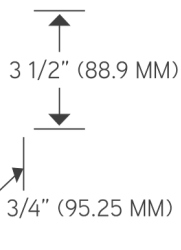

BOTTOM-RAIL PATENT PENDING

Bottom-Rail features a superior design that reduces light gap when the Sheerview Shade is in the lowered/closed position.

Adjustable counter weight keeps sheer shade level

TENSION SAFETY CORD SHEERVIEW SHADE



CORDLESS SHEERVIEW SHADE

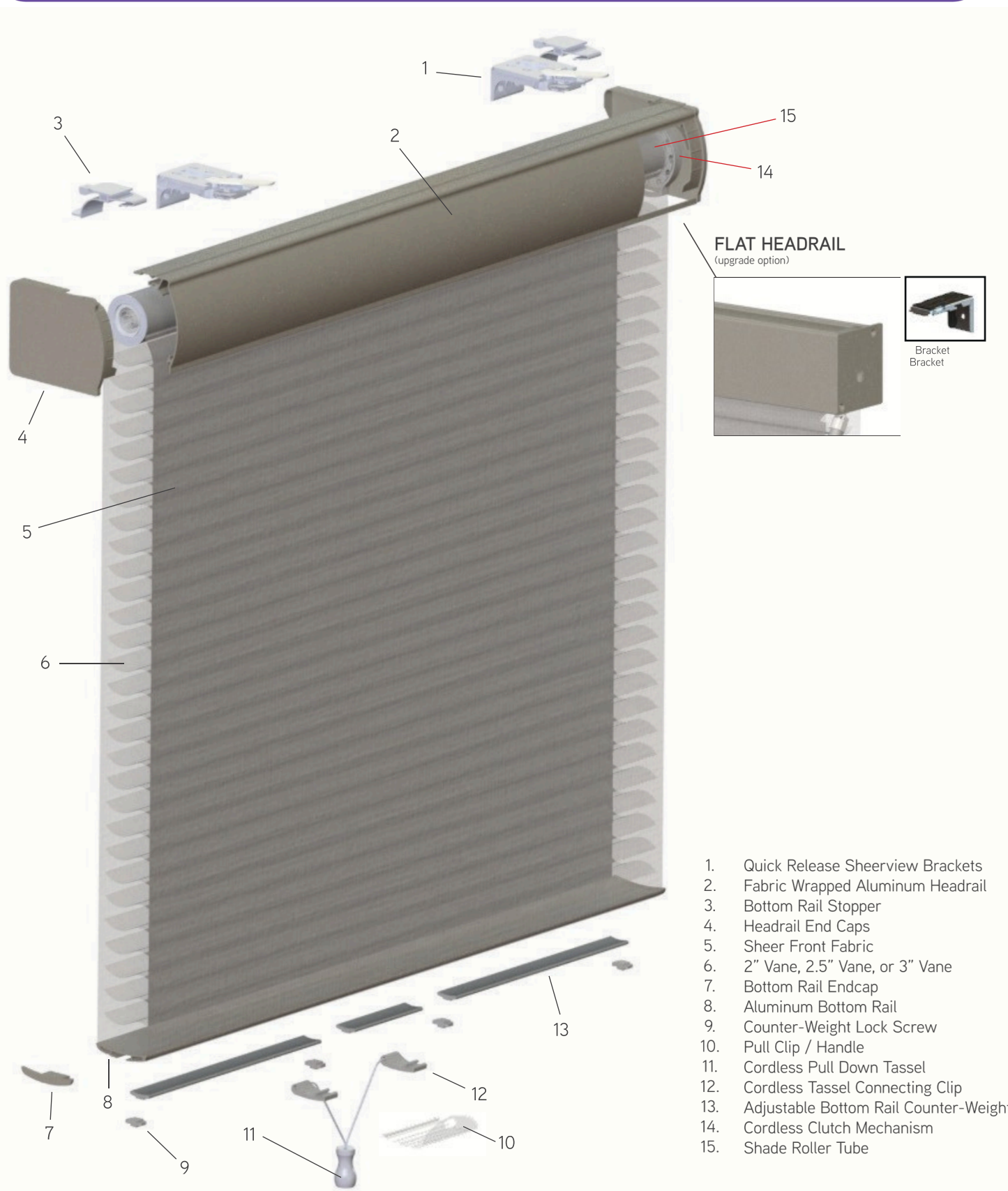

MOTORIZED SHEERVIEW SHADE

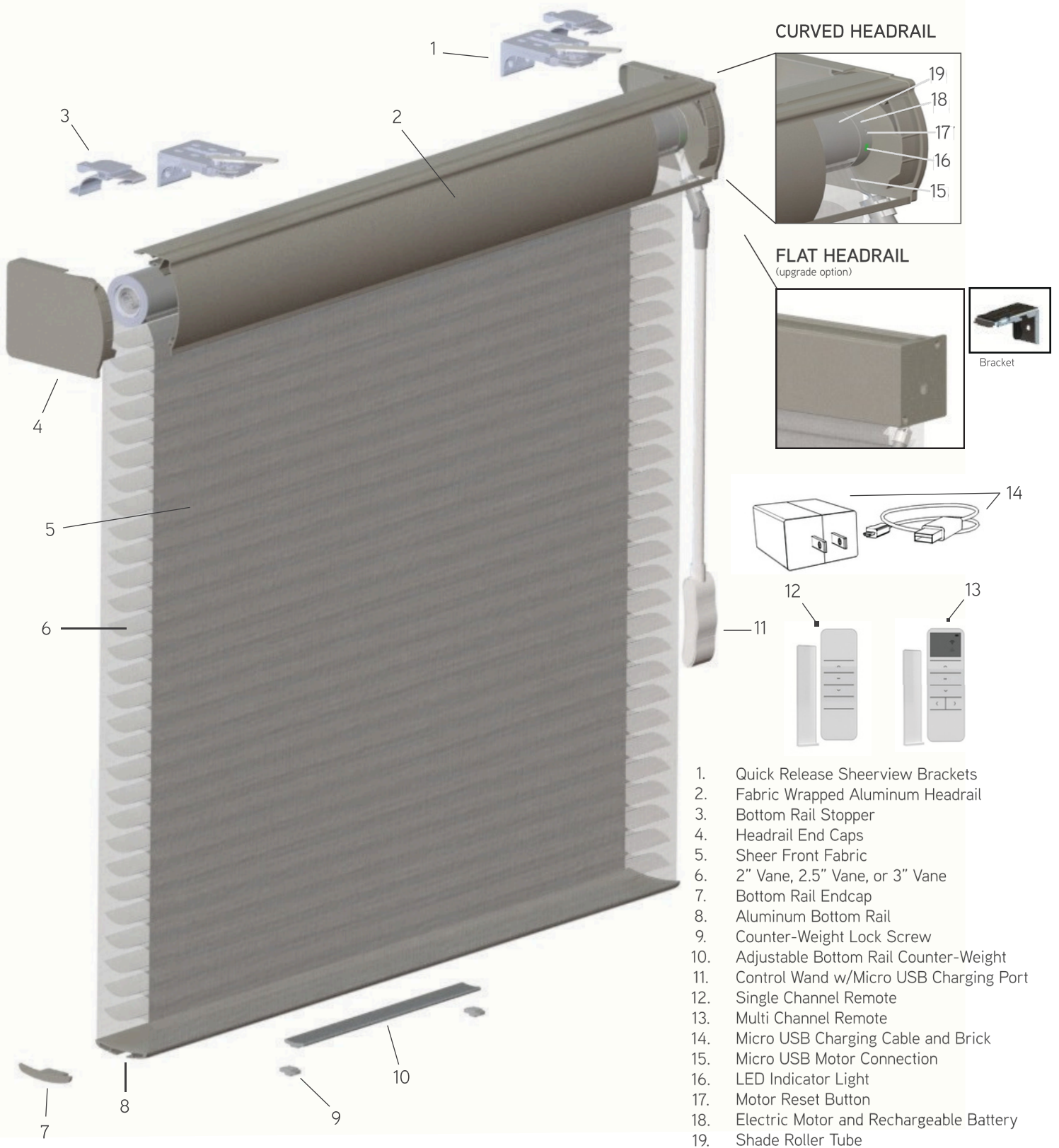

1. Quick Release Sheerview Brackets
2. Fabric Wrapped Aluminum Headrail
3. Bottom Rail Stopper
4. Headrail End Caps
5. Sheer Front Fabric
6. 2" Vane, 2.5" Vane, or 3" Vane
7. Bottom Rail Endcap
8. Aluminum Bottom Rail
9. Counter-Weight Lock Screw
10. Adjustable Bottom Rail Counter-Weight
11. Control Wand w/Micro USB Charging Port
12. Single Channel Remote
13. Multi Channel Remote
14. Micro USB Charging Cable and Brick
15. Micro USB Motor Connection
16. LED Indicator Light
17. Motor Reset Button
18. Electric Motor and Rechargeable Battery
19. Shade Roller Tube

TECHNOLOGY THAT ENHANCES THE LIVING SPACE

OPTION 1: Rechargeable Motor with Wand Control.

OPTION 2: Rechargeable Motor with Radio Remote and Wand Control.

- Easy Installation with No Hard Wiring.
- Long Last Lithium Ion Battery.
- Simple UP/DOWN/STOP Control Buttons for Lift and Tilt Options.
- Micro USB for Charging the Battery

WANDS		MSRP COST	
Replacement Wand		\$175	
CHARGING BRICK & USB CABLE			
6ft Cable	\$50	10ft Cable	\$60



REMOTE CONTROL - OPTIONAL

(Must order motor with radio remote chip)

- Radio remote
- Control your shade with a single-channel or multi-channel remote from up to 100 feet away, with up to 20 shades per channel
- Simple UP/DOWN/STOP Control Buttons for lift and tilt functions
- Remote attaches to backplate via magnets to mount in convenient location
- No pull cords for superior child and pet safety
- Sleek, modern design fits any decor

REMOTE	MSRP COST
Single Channel	\$88
Multi-Channel	\$116



Multi-Channel



Single Channel

These products are designed and manufactured in compliance with Reese's Law (P.L. 117-171), including the safety standard for button cell and coin batteries (16 CFR Part 1263), which incorporates by reference UL 4200A-2023.

SHEERVIEW SHADE FABRIC LIST

COLOR NAME	FLAT RAIL COLOR MATCH	COLOR #	OPACITY	PRICE GROUP
Bright White	S113 - White	S50PN100	2" Light Filtering Sheer Shade	1
Winter White	S113 - White	S50PN113	2" Light Filtering Sheer Shade	1
Beige	S414 - Cornsilk	S50PN322	2" Light Filtering Sheer Shade	1
Alabaster	S322 - Beige	S50PN112	2" Light Filtering Sheer Shade	1
Blossom	S302 - Sesame	S50PN206	2" Light Filtering Sheer Shade	1
Granite	S823 - Rattan	S50PN823	2" Light Filtering Sheer Shade	1
Sesame	S302 - Sesame	S50PN302	2" Light Filtering Sheer Shade	1
Java	S378 - Cocoa	S50PNS378	2" Light Filtering Sheer Shade	1
Bright White	S113 - White	S50PN100D	2" Room Darkening Sheer Shade	4
Beige	S322 - Beige	S50PN322D	2" Room Darkening Sheer Shade	4
Linen	S322 - Beige	S50PN125D	2" Room Darkening Sheer Shade	4
Cornsilk	S302 - Sesame	S50PN414D	2" Room Darkening Sheer Shade	4
Biscuit	S302 - Sesame	S50PN145D	2" Room Darkening Sheer Shade	4
Granite	S823 - Rattan	S50PN823D	2" Room Darkening Sheer Shade	4
Winter White	S113 - White	S50PN113D	2" Room Darkening Sheer Shade	4
Waterfall	S823 - Rattan	S65BN627	2.5" Light Filtering Sheer Shade	2
Beige	S302 - Sesame	S65BN322	2.5" Light Filtering Sheer Shade	2
Heather	S823 - Rattan	S65BN311	2.5" Light Filtering Sheer Shade	2
Blush	S302 - Sesame	S65BN312	2.5" Light Filtering Sheer Shade	2
Granite	S823 - Rattan	S65BN823	2.5" Light Filtering Sheer Shade	2
Blossom	S414 - Cornsilk	S65BN206	2.5" Light Filtering Sheer Shade	2
Parmesan	S322 - Beige	S65BN125	2.5" Light Filtering Sheer Shade	2
Oat	S322 - Beige	S65BN414	2.5" Light Filtering Sheer Shade	2
Foggy	S823 - Rattan	S65BN517	2.5" Light Filtering Sheer Shade	2
Ecru	S302 - Sesame	S65BN207	2.5" Light Filtering Sheer Shade	2
Smoke	S503 - Dolphin Gray	S65BN503	2.5" Light Filtering Sheer Shade	2
Whale	V110 - Night Sky	S65BN822	2.5" Light Filtering Sheer Shade	2
Heather	S823 - Rattan	S65BN311D	2.5 Room Darkening Sheer Shade	5
Blush	S302 - Sesame	S65BN312D	2.5 Room Darkening Sheer Shade	5
Blossom	S414 - Cornsilk	S65BN206D	2.5 Room Darkening Sheer Shade	5
Beige	S302 - Sesame	S65BN322D	2.5 Room Darkening Sheer Shade	5
Granite	S823 - Rattan	S65BN823D	2.5 Room Darkening Sheer Shade	5
Waterfall	S823 - Rattan	S65BN627D	2.5 Room Darkening Sheer Shade	5

SHEERVIEW SHADE FABRIC LIST

COLOR NAME	FLAT RAIL COLOR MATCH	COLOR #	OPACITY	PRICE GROUP
Bright White	S113 - White	S70PN100	3" Light Filtering Sheer Shade	3
Winter White	S113 - White	S70PN113	3" Light Filtering Sheer Shade	3
Beige	S414 - Cornsilk	S70PN322	3" Light Filtering Sheer Shade	3
Alabaster	S322 - Beige	S70PN112	3" Light Filtering Sheer Shade	3
Blossom	S302 - Sesame	S70PN206	3" Light Filtering Sheer Shade	3
Granite	S823 - Rattan	S70PN823	3" Light Filtering Sheer Shade	3
Sesame	S302 - Sesame	S70PN302	3" Light Filtering Sheer Shade	3
Java	S378 - Cocoa	S70PNS378	3" Light Filtering Sheer Shade	3
Romance	S322 - Beige	S70PN323	3" Light Filtering Sheer Shade	3
Luna	S322 - Beige	S70PN126	3" Light Filtering Sheer Shade	3
Celadon	S517 - Celadon	S70PN517	3" Light Filtering Sheer Shade	3
Coastal Plain	S503 - Dolphin Gray	S70PN503	3" Light Filtering Sheer Shade	3
Plank	S378 - Cocoa	S70PN371	3" Light Filtering Sheer Shade	3
Rhinestone	ZY090 - Sage	S70PN824	3" Light Filtering Sheer Shade	3
Dusty Blue	V110 - Night Sky	S70PN821	3" Light Filtering Sheer Shade	3
Bright White	S113 - White	S70PN100D	3" Room Darkening Sheer Shade	6
Beige	S322 - Beige	S70PN322D	3" Room Darkening Sheer Shade	6
Linen	S322 - Beige	S70PN125D	3" Room Darkening Sheer Shade	6
Cornsilk	S302 - Sesame	S70PN414D	3" Room Darkening Sheer Shade	6
Biscuit	S302 - Sesame	S70PN145D	3" Room Darkening Sheer Shade	6
Granite	S823 - Rattan	S70PN823D	3" Room Darkening Sheer Shade	6
Java	S378 - Cocoa	S70PNS378D	3" Room Darkening Sheer Shade	6
Greek Villa	ZY090 - Sage	S70PN114D	3" Room Darkening Sheer Shade	6
Eggshell	S322 - Beige	S70PN111D	3" Room Darkening Sheer Shade	6
Natural Tan	S414 - Cornsilk	S70PN321D	3" Room Darkening Sheer Shade	6
Barcelona Beige	S414 - Cornsilk	S70PN312D	3" Room Darkening Sheer Shade	6
Khaki	S823 - Rattan	S70PN303D	3" Room Darkening Sheer Shade	6
Brick	L334 - Pecan	S70PN334D	3" Room Darkening Sheer Shade	6
Lazy Gray	ZY090 - Sage	S70PN822D	3" Room Darkening Sheer Shade	6
Midnight	V110 - Night Sky	S70PN016D	3" Room Darkening Sheer Shade	6
Royal Blue	V110 - Night Sky	S70PN029D	3" Room Darkening Sheer Shade	6
Coastal Plain	S503 - Dolphin Gray	S70PN503D	3" Room Darkening Sheer Shade	6

PRICE GROUP 1 CCL | 2" | LIGHT FILTERING | NON WOVEN

Height Up To	Width Up To												
	24"	30"	36"	42"	48"	54"	60"	66"	72"	84"	96"	108"	116"
36"	461	513	567	619	673	727	778	835	966	1077	1184	1302	1498
42"	484	540	596	658	713	776	835	893	1026	1146	1263	1389	1597
48"	511	567	632	693	759	822	892	957	1094	1217	1348	1484	1705
54"	528	595	662	733	804	874	946	1022	1158	1292	1438	1582	1818
60"	551	627	697	771	843	923	1002	1081	1213	1371	1530	1683	1935
66"	572	653	732	811	893	976	1064	1148	1281	1455	1626	1789	2058
72"	596	682	765	849	940	1031	1126	1213	1348	1532	1718	1889	2173
78"	610	704	794	882	977	1076	1170	1270	1410	1607	1800	1980	2276
84"	637	732	823	927	1027	1129	1238	1337	1481	1694	1896	2086	2398
90"	661	759	858	967	1074	1187	1293	1403	1550	1774	1991	2191	2517
96"	685	792	895	1007	1126	1238	1354	1466	1622	1855	2084	2292	2635
102"	776	893	1010	1135	1253	1365	1517	1666	1777	2013	2242	2467	2837
108"	815	936	1060	1193	1313	1433	1594	1749	1866	2115	2359	2595	2984
114"	863	992	1124	1263	1399	1523	1689	1855	1980	2242	2502	2751	3164
120"	923	1058	1204	1350	1487	1626	1805	1980	2117	2399	2673	2940	3380
132"	1060	1217	1385	1553	1709	1870	2074	2277	2433	2760	3074	3380	3888
144"	1219	1399	1592	1786	1966	2152	2384	2618	2799	3172	3534	3888	4471

SUGGESTED RETAIL PRICE

Shades 93" or wider incur an additional net \$100.00 charge per box for each order (maximum 2 shades per box).

PRICE GROUP 2 CCL | 2.5" | LIGHT FILTERING | NON WOVEN

Smallest width available 7.5" exact for manual shade.
Smallest width available 24" exact for Motorized shade

Height Up To	Width Up To												
	24"	30"	36"	42"	48"	54"	60"	66"	72"	84"	96"	108"	116"
36"	530	591	653	712	774	837	895	960	1110	1237	1363	1498	1722
42"	556	621	686	758	820	893	960	1026	1181	1317	1453	1598	1836
48"	587	653	726	797	872	946	1025	1099	1258	1400	1551	1705	1961
54"	607	685	763	843	925	1004	1089	1175	1332	1485	1653	1818	2091
60"	632	721	803	888	969	1060	1152	1243	1395	1577	1758	1935	2225
66"	658	749	842	931	1026	1123	1226	1319	1472	1674	1870	2058	2365
72"	686	783	879	977	1079	1185	1294	1395	1551	1760	1975	2173	2498
78"	701	809	912	1016	1124	1236	1347	1462	1621	1849	2070	2277	2618
84"	731	842	947	1065	1182	1297	1423	1538	1703	1947	2180	2399	2759
90"	761	872	987	1112	1235	1366	1486	1614	1782	2039	2290	2517	2896
96"	787	909	1029	1158	1294	1423	1557	1686	1865	2135	2396	2635	3030
102"	893	1026	1162	1305	1440	1569	1744	1916	2044	2314	2579	2838	3263
108"	938	1077	1219	1372	1511	1649	1833	2010	2145	2432	2713	2984	3431
114"	993	1142	1291	1453	1607	1752	1942	2135	2277	2579	2877	3165	3637
120"	1060	1217	1385	1553	1709	1870	2074	2277	2433	2760	3074	3380	3888
132"	1219	1399	1592	1786	1966	2152	2384	2618	2799	3172	3534	3888	4471
144"	1401	1608	1831	2053	2260	2474	2744	3011	3218	3648	4065	4470	5141

SUGGESTED RETAIL PRICE

Shades 93" or wider incur an additional net \$100.00 charge per box for each order (maximum 2 shades per box).

PRICE GROUP 3

CCL | 3" | LIGHT FILTERING | NON WOVEN

Smallest width available 7.5" exact for manual shade.
Smallest width available 24" exact for Motorized shade

Height Up To	Width Up To												
	24"	30"	36"	42"	48"	54"	60"	66"	72"	84"	96"	108"	116"
36"	520	577	638	695	758	819	876	940	1086	1210	1332	1465	1684
42"	542	609	671	740	803	873	940	1004	1156	1289	1421	1565	1798
48"	576	639	711	779	853	926	1002	1076	1230	1369	1516	1668	1917
54"	594	670	745	825	904	981	1063	1149	1302	1451	1619	1780	2047
60"	619	706	784	867	947	1036	1128	1216	1365	1542	1721	1894	2177
66"	642	733	824	913	1004	1098	1200	1292	1440	1635	1830	2013	2313
72"	671	766	860	955	1057	1161	1264	1365	1516	1724	1933	2124	2442
78"	686	793	893	992	1099	1210	1318	1428	1585	1809	2025	2228	2561
84"	716	824	926	1043	1156	1268	1392	1504	1666	1905	2135	2347	2698
90"	744	853	966	1089	1209	1336	1454	1579	1744	1995	2239	2462	2832
96"	769	890	1007	1133	1264	1393	1523	1650	1825	2088	2345	2580	2966
102"	873	1005	1136	1279	1410	1534	1706	1872	1998	2265	2522	2774	3190
108"	916	1055	1192	1343	1477	1614	1792	1966	2100	2380	2652	2918	3356
114"	971	1116	1263	1421	1572	1713	1902	2086	2227	2522	2814	3096	3558
120"	1038	1188	1352	1520	1672	1830	2030	2227	2380	2698	3006	3307	3804
132"	1192	1367	1555	1749	1923	2104	2333	2561	2736	3103	3457	3803	4373
144"	1371	1572	1789	2010	2212	2420	2685	2946	3148	3569	3976	4372	5030

SUGGESTED RETAIL PRICE

Shades 93" or wider incur an additional net \$100.00 charge per box for each order (maximum 2 shades per box).

PRICE GROUP 4

CCL | 2" | ROOM DARKENING | NON WOVEN

Smallest width available 7.5" exact for manual shade.
Smallest width available 24" exact for Motorized shade

Height Up To	Width Up To												
	24"	30"	36"	42"	48"	54"	60"	66"	72"	84"	96"	108"	116"
36"	508	564	623	682	740	800	856	918	1061	1184	1302	1433	1648
42"	532	594	656	724	784	854	918	981	1129	1260	1389	1529	1757
48"	562	623	694	763	834	905	980	1052	1203	1338	1484	1631	1875
54"	580	655	730	806	884	961	1042	1125	1272	1420	1582	1739	2000
60"	605	690	768	848	927	1014	1101	1188	1335	1508	1683	1851	2128
66"	630	719	805	892	981	1073	1173	1262	1409	1602	1789	1969	2264
72"	656	748	842	933	1032	1134	1238	1335	1484	1685	1889	2078	2390
78"	671	774	873	972	1074	1182	1288	1399	1550	1768	1980	2178	2506
84"	698	805	906	1019	1131	1242	1363	1470	1629	1862	2086	2295	2639
90"	727	834	945	1063	1181	1307	1421	1542	1705	1952	2191	2409	2769
96"	752	870	984	1108	1238	1363	1489	1614	1784	2040	2292	2521	2899
102"	854	981	1111	1248	1377	1500	1669	1832	1955	2215	2467	2713	3119
108"	896	1029	1166	1313	1445	1577	1753	1922	2053	2326	2595	2854	3283
114"	949	1092	1234	1389	1538	1675	1859	2040	2178	2467	2751	3027	3481
120"	923	1164	1325	1486	1634	1789	1984	2178	2327	2639	2940	3234	3720
132"	1060	1338	1522	1707	1881	2058	2281	2506	2676	3035	3380	3720	4277
144"	1219	1539	1751	1965	2162	2365	2623	2880	3079	3489	3888	4277	4918

SUGGESTED RETAIL PRICE

Shades 93" or wider incur an additional net \$100.00 charge per box for each order (maximum 2 shades per box).

PRICE GROUP 5 CCL | 2.5" | ROOM DARKENING | NON WOVEN

Smallest width available 7.5" exact for manual shade.
Smallest width available 24" exact for Motorized shade

Height Up To	Width Up To												
	24"	30"	36"	42"	48"	54"	60"	66"	72"	84"	96"	108"	116"
36"	559	621	686	750	815	880	943	1010	1167	1303	1433	1576	1813
42"	586	655	721	797	863	941	1010	1080	1242	1387	1528	1682	1933
48"	618	686	764	840	918	996	1079	1158	1323	1472	1632	1794	2063
54"	638	720	803	888	973	1058	1147	1238	1400	1563	1741	1914	2201
60"	666	760	845	933	1021	1116	1211	1308	1469	1659	1852	2036	2342
66"	693	792	887	981	1080	1181	1290	1389	1550	1762	1968	2167	2490
72"	721	823	926	1027	1136	1247	1362	1469	1632	1854	2078	2286	2630
78"	739	852	960	1070	1182	1300	1417	1540	1705	1945	2178	2397	2756
84"	769	887	998	1121	1244	1367	1499	1618	1792	2048	2295	2525	2903
90"	800	918	1039	1170	1299	1438	1564	1697	1876	2147	2410	2650	3047
96"	828	957	1083	1219	1362	1499	1638	1776	1963	2245	2521	2774	3189
102"	941	1080	1222	1373	1516	1651	1836	2016	2150	2436	2715	2984	3431
108"	986	1132	1284	1445	1590	1735	1929	2115	2259	2559	2855	3140	3611
114"	1045	1202	1358	1528	1692	1842	2045	2245	2397	2715	3027	3330	3830
120"	1016	1281	1459	1634	1799	1968	2182	2397	2560	2903	3234	3557	4092
132"	1166	1472	1675	1879	2069	2264	2510	2756	2945	3339	3718	4092	4705
144"	1342	1693	1927	2162	2378	2603	2886	3168	3387	3838	4277	4705	5410

SUGGESTED RETAIL PRICE

Shades 93" or wider incur an additional net \$100.00 charge per box for each order (maximum 2 shades per box).

PRICE GROUP 6 CCL | 3" | ROOM DARKENING | NON WOVEN

Smallest width available 7.5" exact for manual shade.
Smallest width available 24" exact for Motorized shade

Height Up To	Width Up To												
	24"	30"	36"	42"	48"	54"	60"	66"	72"	84"	96"	108"	116"
36"	572	635	701	765	832	899	964	1032	1193	1332	1465	1611	1853
42"	597	670	738	814	882	960	1032	1103	1270	1418	1565	1719	1978
48"	634	704	780	857	938	1018	1101	1182	1352	1505	1668	1834	2109
54"	654	737	820	908	995	1080	1170	1264	1432	1596	1780	1958	2252
60"	682	776	863	954	1043	1139	1241	1337	1500	1698	1894	2082	2395
66"	707	806	907	1004	1103	1208	1319	1420	1583	1800	2013	2214	2545
72"	738	843	946	1051	1163	1276	1390	1500	1668	1896	2124	2338	2687
78"	753	871	981	1092	1209	1332	1449	1572	1742	1990	2228	2450	2818
84"	788	907	1018	1147	1270	1395	1532	1656	1832	2095	2347	2582	2968
90"	819	938	1061	1199	1330	1469	1599	1737	1919	2195	2462	2710	3115
96"	845	978	1108	1246	1390	1533	1675	1815	2008	2296	2580	2837	3263
102"	960	1106	1252	1406	1550	1687	1877	2061	2197	2490	2774	3052	3508
108"	1007	1161	1312	1476	1625	1775	1973	2162	2309	2618	2918	3209	3691
114"	1068	1228	1389	1565	1730	1885	2091	2295	2449	2774	3096	3404	3914
120"	1141	1309	1488	1671	1840	2013	2232	2449	2618	2968	3307	3638	4183
132"	1312	1504	1712	1922	2117	2314	2567	2817	3010	3414	3803	4183	4810
144"	1508	1731	1968	2210	2433	2662	2952	3239	3462	3924	4372	4810	5533

SUGGESTED RETAIL PRICE

Shades 93" or wider incur an additional net \$100.00 charge per box for each order (maximum 2 shades per box).

MEASURING

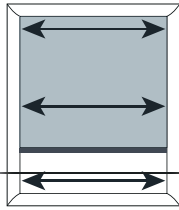

INSIDE MOUNT WIDTH (IB)

- Measure the exact width of the inside edge of the window frame. - Top, Middle, and Bottom.
- Make all measurements to the nearest 1/8th inch, round DOWN for width.
- Take the SMALLEST of the 3 measurements, this is the width that you will order.
- Production department will make the necessary deductions to ensure the shade fits inside your window.

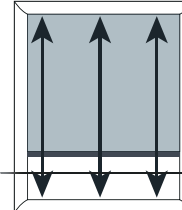

INSIDE MOUNT HEIGHT (IB)

- Measure the exact height from the top inside edge down to the window sill in 3 places. - Left, Middle, Right
- Make all measurements to the nearest 1/8th inch, round UP for height.
- Take the LARGEST of the 3 measurements, this is the height that you will order.

NOTE: IB - THE FACTORY WILL DEDUCT 1/8-3/16" OFF THE TOTAL WIDTH.
OB - THE FACTORY WILL MAKE THE PRODUCT TO THE EXACT MEASUREMENTS PROVIDED.

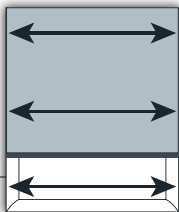

OUTSIDE MOUNT WIDTH (OB)

- Measure the exact width of the window frame or how wide you would like the shade to be.
- Be sure to measure wide enough to cover the entire window (and trim if desired) to provide maximum light coverage.
- Example: If the window opening is 36" wide, it might be helpful to order 40" if the space allows. This will provide 2" coverage on each side of the window.
- No deductions/additions will be made to the width ordered.

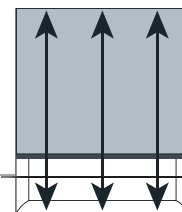

OUTSIDE MOUNT HEIGHT (OB)

- Measure the height you would like the shade to be by measuring top to bottom.
- Be sure to measure high enough to cover the entire window (and trim if desired) to provide maximum light coverage.
- Example: If the window opening is 60" high, it might be helpful to order 64" if the space allows. This will provide 2" coverage on top and bottom of the window.
- No deductions/additions will be made to the height ordered.

Shades can be +/- an additional 1/8" within factory standard post production.

MISCELLANEOUS INFORMATION

CLEANING AND CARE INFORMATION

Sheerview Shades are uniquely low-maintenance, needing only periodic vacuuming on a low setting and occasional feather dusting. The sheer fabric may also be ultrasonically cleaned.

FINISHED DIMENSIONS

Once ordered and manufactured, the width of the fabric cannot be altered. The Manufacturer makes deductions to the width of window shadings depending on the type of mounting indicated. For all mounting types, the fabric will measure exactly the length ordered when the vanes are in the open or "view-through" position. When the vanes are rotated to the closed position, the shading will become 3/8" longer.

MEASUREMENT CONSIDERATIONS

When closed on an inside mount, a slight furrow may occur on the lowermost sheer section because of contact with the sill. To compensate, slightly raise the shading until the rail begins to lift off the window sill.

If preferred, the shading can be ordered 3/8" less than the measured height of the window opening. In this case, the bottom rail will be positioned 3/8" above the sill when the vanes are in the open position. Rotating the vanes closed will cause the bottom rail to touch the window sill and thus closing any unwanted space.

HEADRAIL INFORMATION

INSIDE MOUNT

Minimum depth for flush inside mount including installation brackets: 3 1/4"

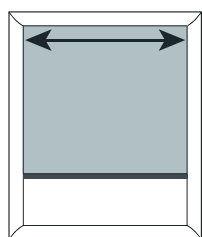

OUTSIDE MOUNT

Minimum surface area required for mounting: 3/4"

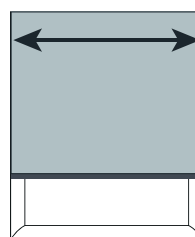

CORD INFORMATION

CORDS WILL NO LONGER BE AVAILABLE ON ANY PRODUCTS SOLD BY THE MANUFACTURER, IN COMPLIANCE WITH NEW CPSC GUIDELINES UNLESS FOR SAFETY TENSION DEVICE.

The Consumer Product Safety Commission has announced new guidelines, to go into effect May 20, 2023, restricting the manufacture of corded custom window treatments in the interest of child safety. In accordance with the new CPSC guidelines, the Manufacturer will no longer be producing any window treatments with cords.

PRODUCT OPERATION

SHADING OPERATION

The Sheerview Horizontal Sheer Shade features a control system with the ability to manipulate the shading into various viewing positions. From the closed and retracted position (fabric inside the headrail), lower the fabric by pulling down on the rear of the cord until you reach the desired shading position. Once lowered completely to the window sill, continuing to pull the cord in the same direction will open the horizontal fabric vanes, offering varied views to the outside. To retract the shading, pull down on the front of the cord until the shading reaches the desired viewing mode or fabric position. Shade will not tilt open unless fully lowered.

HARDWARE

- Installation Headrail Brackets
- Multi-faceted bracket system includes breakaway shims to assist in leveling. The bracket also includes easy release lever.
- Spacer Blocks – Upon Request Only
- Spacer blocks project the shading 3/8" from the mounting surface. Use spacer blocks to obtain clearance when obstructions, such as window cranks or door handles, obstruct the movement of shading.
- Hold Down Brackets – Upon Request Only
- Hold down brackets are made of clear plastic that fit into holes on the end-cap of the bottom rail. Hold downs are generally used to secure the base of the window shading to prevent swaying.

SKEW ADJUSTING BOTTOM RAIL

The Sheerview Horizontal Sheer Shades are leveled and weighed in the factory. When installed level, the fabric will not skew when raised. If the headrail is not installed level, skewing can occur that can damage the edge of the fabric. Be sure to follow the instructions below carefully to ensure correct and balanced operation.

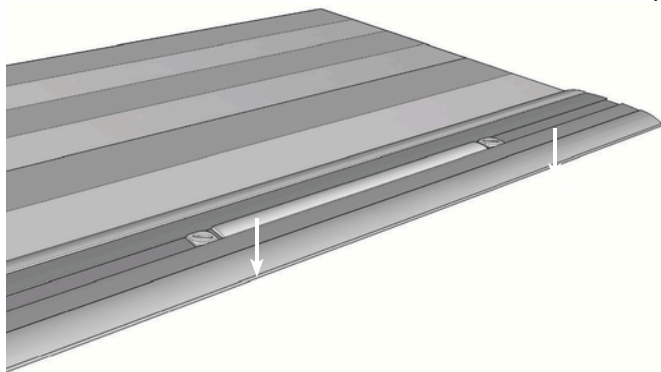

Turn over the bottom rail use a flat head screwdriver to twist both stoppers on the left and right side of the counterweight slide.

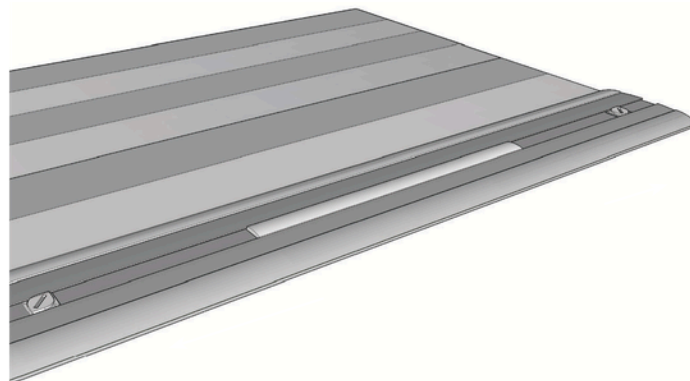

Slide the bar to where the counterweight is needed to combat the shifting of the shades. Twist down with a flathead screwdriver on both stoppers in order to re-lock the counterweights.

PROGRAMMING INFORMATION

WARNING

OUR MOTORIZED PRODUCTS COME PREPROGRAMMED FROM THE FACTORY SPECIFICALLY FOR YOUR WINDOW HEIGHTS AND TO YOUR MOTOR.

THIS INFORMATION SHOULD **ONLY** BE USED IF:

1. THE PROGRAMMING HAS BEEN ACCIDENTALLY ERASED
2. AT THE ADVICE OF THE MANUFACTURER.

* PLEASE UNDERSTAND THAT TECHNICAL SUPPORT IS AT THE DISCRETION OF THE MANUFACTURER IN CASES OF UNAUTHORIZED SYSTEM RESETS.

PAIRING A WIRELESS REMOTE (ONLY IF YOUR MOTOR WAS ORDERED WITH THE WIRELESS UPGRADE)

To pair a wireless remote:

1. Using a paperclip **PRESS** and **HOLD** the **RESET** button on the back of the wand for approximately **3 SECONDS** (shade will jog and beep once).



2. Immediately after the shade jog and beep: **PRESS** the **UP**  button once on your wireless remote (the shade will jog once and beep 3 times confirming pairing success). If using a multi-channel remote make sure to have the desired channel selected prior to starting the process.

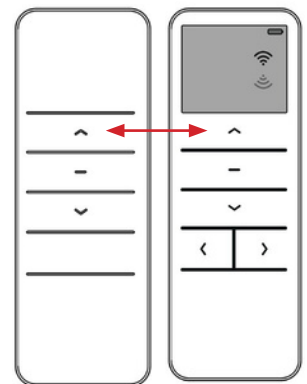



SETTING/ADJUSTING LIFT LIMITS

CHECKING LIFT

While pressing the **UP**  button and shade goes up automatically, your shade is in **NORMAL** mode. When pressing button your shade is not moving up automatically, your shade is in **RESET** mode. (Go to SETTING OPEN/CLOSED LIMIT)

To enter/ close **RESET** mode, press and hold the **UP**  + **DOWN**  buttons at the same time until you hear beep.



SETTING OPEN/ CLOSED LIMIT

1. **PRESS** and **HOLD** the **UP**  + **STOP**  button at the same time until shade jogs (goes in a downward then upward motion). Once you let go of buttons, you are now in **SET-UP** mode.

2. In this mode, **ADJUST SHADE** by pressing **UP** to the desired **OPEN LOCATION**. **TIP:** holding button (to continuous movement) or tapping button (to slowly bump).

3. Once at desired location, press the **UP**  + **STOP**  buttons together and you will hear beep to confirm setting.

****THIS WILL BE THE SAME WHEN SETTING THE DOWN  BUTTON AND USING THE DOWN  + STOP  BUTTONS.**

After setting both the top and bottom limits, press and hold the **UP**  + **DOWN**  buttons together, and the shade will go up and down once (Let go with both buttons). Once you hear 2 BEEPS, you are out of **RESET** mode and back into **NORMAL** mode.

SHEERVUEW

HORIZONTAL SHEER SHADE

