Installation Manual

Dual Sheer Shades

Thank you for purchasing custom Dual Sheer Shades. With proper installation, your shades should look beautiful and provide years of service. Please check all parts and review this manual before starting installation.

Keep this manual after your shades are installed and operating correctly. It contains important troubleshooting instructions for your shades.

CONTENTS:

Page 1: Mounting Hardware and Required Tools

Page 2: Installing Your Shade

Page 3: Shade Care and Cleaning

Page 4: Cordless Control - Operating

Page 5: Cordless Control - Troubleshooting

Page 6 - 7: Troubleshooting Shades

Page 8: Shade Warranty

MOUNTING HARDWARE:

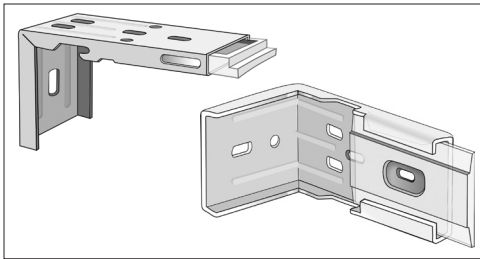

**Universal Mounting Brackets and Screws
(for inside/top and outside/face mounting)**

Ordered Width (Inches)	Brackets Supplied
Up to 54"	2 Brackets
Between 55" and 78"	3 Brackets
Between 79" and 98"	4 Brackets
Between 98" and 110"	5 Brackets

TOOLS THAT MAY BE REQUIRED:

Pencil, Tape Measure, Drill, Screw Driver, Level, and Step Stool

INSTALLING YOUR SHEER SHADE

NOTE: For wallboard or plaster, use anchors designed for hollow walls (not included). For concrete, stone, and brick, use a masonry drill bit and masonry anchors (not included).

STEP A: INSTALL BRACKETS

Your Dual Sheer Shade has universal brackets for inside (top) or outside (face) mounting.

- 1. Before beginning installation, fit the brackets into the cassette.** See how the white plastic bracket lip fits under the front rib of the cassette, and then push on the back of the bracket to compress it until it snaps into place. The hooks on the bracket are now caught on the back rib of the cassette. Push again on the bracket back to remove it.
- 2. Mark the desired position of the brackets with a pencil.** Position one bracket within 2" from each end cap of the cassette. Then, space out any middle brackets equally (if supplied). Check the table on page 1 to see brackets supplied by shade width. **NOTE:** It is essential to install all brackets provided, ensuring that any middle brackets are equally spaced. This is required to ensure that your shade will hang with no waviness in the fabric. For more details see Bracket Installation troubleshooting on page 7.

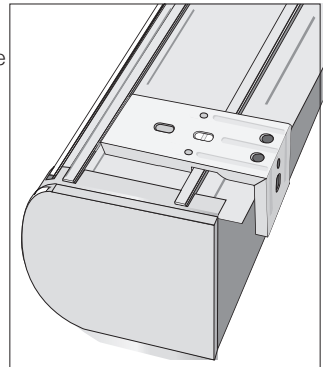

Cassette and Bracket

- 3. Drill pilot holes for the screws.**
- 4. Use provided screws to install brackets.** Ensure the brackets are level and in line with each other. The cassette may not snap properly into all brackets if they are not level.

STEP B: INSTALL SHADE

- 1. Position the bracket under the front rib on the cassette.** Tilt the front of the dual sheer up and hook the white plastic bracket lip under the front rib on the top of the cassette.
- 2. Snap cassette into place*.** Now push the cassette back and up until all brackets snap into place.

SHADE CARE AND CLEANING

We recommend gentle cleaning methods for the care and cleaning of your Dual Sheer Shades.

Dual Sheer Shades are decorative in nature and are made using polyester materials. The fabrics in this collection should not be treated with harsh chemicals.

When dusting is required, be sure to use something gentle. We recommend a vacuum brush or lightly dusting by hand.

Light steaming may be used in the event of wrinkles. Please be sure to avoid contact with the fabric and hold the steamer at least 6" away.

Use only water or a very mild detergent if spot cleaning is required. Cleaning the shade in its entirety can cause it to shrink, leave water spots, or alter the fabric's color.

Following these tips will help extend the life of your shades and ensure they stay beautiful for years to come!

CONTROL TYPE INSTRUCTIONS

CLUTCH CONTROLS: please see Cord Tensioner installation instructions (included separately).

CORDLESS CONTROL: move on to page 4 for operating and troubleshooting instructions.

WAND CONTROL: please see Motorization User Manual for operation and troubleshooting instructions (included separately).

REMOTE CONTROLS: please see Motorization User Manual for operation and troubleshooting instructions (included separately).

CORDLESS CONTROL - OPERATING

SHADE OPERATION

Always operate shades from the center of the bottom bar to ensure shades are raised and lowered correctly.

TO LOWER SHADE:

Pull straight down on the center of the bottom bar to lower the shade to the desired position.

TO RAISE SHADE:

Push the center of the bottom bar up to raise the shade to exact desired position.

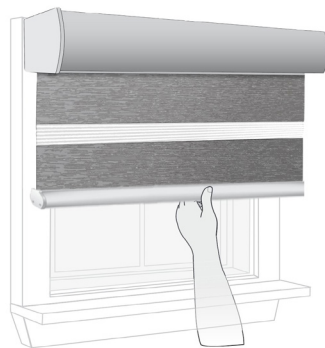

IMPROPER USE WILL LEAD TO:

Misalignment of panels, creasing, or fraying of panel edges, and/or separation of panels from each other, the bottom bar, or cassette.

CORDLESS CONTROL - TROUBLESHOOTING

ADJUST SHADE TENSION

Shade tension can be easily adjusted to improve the operation of cordless shades.

NOTE: This is a fine adjustment control. Following the instructions below, it may be required to rotate the screw 5+ full turns to make any tension changes.

UNABLE TO RAISE / BILLOWING / DRIFTING DOWNWARD

If the shade will not raise, billows when raising, or drifts downward instead of staying in a desired position, the tension needs to be increased.

Remove the end cap on the right side of the cassette to access the tensioning screw. Turn the screw to the **LEFT** (counter-clockwise) to increase tension for stronger pull/ increased hold.

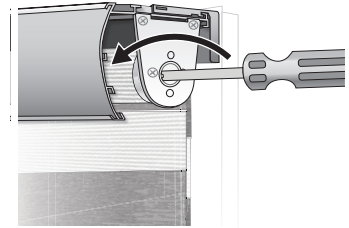

Tension Control: To **INCREASE** tension, turn **LEFT** (Counter-clockwise)

DRIFTING UPWARD / RAISING TOO QUICKLY

If the shade drifts up or rises after being positioned, the tension needs to be decreased.

Turn the screw to the **RIGHT** (clockwise) to decrease tension, lessening the strength of the spring.

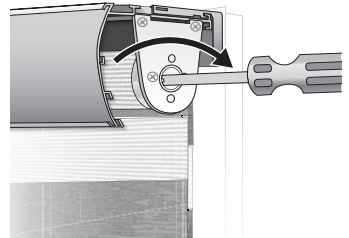

Tension Control: To **DECREASE** tension, turn **RIGHT** (Clockwise)

TROUBLESHOOTING SHADES

SHADE FABRIC IS OVERWOUND

Dual sheer shades are designed so that both layers of the fabric panel are at the back of the shade roll with a very small gap between them. **[Figure 1]**

If shades become overwound there will be a larger gap and less light blockage. **[Figure 2]**

To correct an overwound shade:

- Lower the shade fully.
- Once fully lowered, continue lowering the shade and notice that the fabric will start to wind around the back of the tube, closing the gap between the two layers.
- To keep shades from becoming overwound:

Clutch Control Shades:

- **Raise** using the **front** of the cord/chain loop.
- **Lower** using the **back** of the cord/chain loop.

Wand or Remote Motorized Shades: Always set stop limits that are not in an overwound position.



Figure 1: Shade fabric comes off back of roll

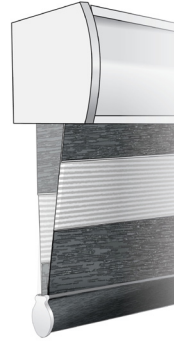

Figure 2: Overwound shade fabric

SHADE FABRIC IS NOT ALIGNED

The back panel of dual sheer shades should be perfectly in line with the front panel to ensure proper operation. **[Figure 3]**

If the panels are not aligned, it can result in frayed fabric edges or waves in your shade fabric. **[Figure 4]**

To correct unaligned shade fabric:

- Start by fully lowering the shade.
- Then, gently pull the back fabric panel in line with the front. **[Figure 5]**



Figure 3: Shade fabric aligned

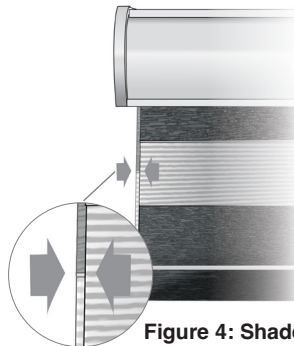

Figure 4: Shade fabric not aligned

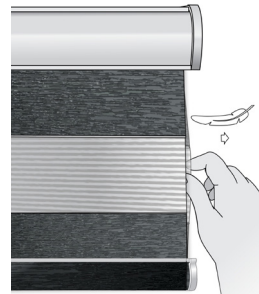

Figure 5: Correcting unaligned fabric

TROUBLESHOOTING SHADES (continued)

SHADE FABRIC IS WAVY

If dual sheer shade fabric appears wavy after the shade is installed, review the notes below:

Shade Fabric Not Aligned

- If the front and back panels of the dual sheer shade are not perfectly aligned, waviness in the fabric can occur. Follow the instructions on page 6 for correcting unaligned shade fabric.

Bracket Installation

- It is essential to install dual sheer shades using all brackets provided. See the chart on page 1.
- Ensure that the brackets are correctly spaced. The brackets on the two far ends of the shade should be spaced within 2" from either shade end cap. If more than two brackets were supplied, they should be spaced evenly between the two end brackets.
- Also ensure that brackets are installed straight across the window. If brackets are not aligned, it can force the cassette to warp (or bend) when snapped into the brackets, leading to waviness in the shade.
- Proper bracket installation will allow balance for the shade and alleviate waviness.

Shade Static

- If the shade is still showing waves through the fabric after checking that the fabric is aligned and the brackets are correctly installed, try spraying liquid anti-static on the shade.

Contact Customer Service if there is still waviness in your shade after trying these tips.

SHADE WARRANTY

WHAT IS COVERED BY THIS WARRANTY?

This shade is warranted against defects in materials and workmanship, provided that:

1. The product was installed according to the product instructions.
2. Our recommendations were followed regarding limitations and specifications of the product.

We reserve the right to determine if your shade warrants a repair or partial replacement of any parts. If necessary, we will replace your shade with a new shade of equal or superior value. This shall be your sole remedy under this warranty.

All motors, remote controls and wand motors are warranted for a period of five years from the date of purchase.

WHO IS COVERED BY THIS WARRANTY?

This warranty applies only to the original retail purchaser with proof of purchase in the USA.

WHAT IS NOT COVERED BY THIS WARRANTY?

Your shade may also show some fading and discoloration over time. This is not considered a defect for the purposes of this warranty.

This warranty does not cover the removal or installation of original or replacement shades. This warranty does not cover damage or defects caused by, or resulting from improper maintenance, neglect or improper use, wear and tear, abuse, neglect, accidents, alteration, commercial use, installation, removal or reinstallation or exposure to excessive moisture.

Failure to follow the proper installation, charging and use instructions will invalidate the warranty for motors, remotes and wand motors.

YOUR RIGHTS UNDER STATE LAW

This warranty gives you specific legal rights. You may also have other rights which may vary from State to State. In no event shall we be liable for incidental or consequential damages or for any other direct or indirect damage, loss, cost, expense or fee. Some states do not allow the exclusion or limitation of incidental or consequential damages, so the above limitation or exclusion may not apply to you. This warranty is exclusive and in lieu of all other obligations, liabilities or warranties.

If you have any questions or concerns, please contact Customer Service.